

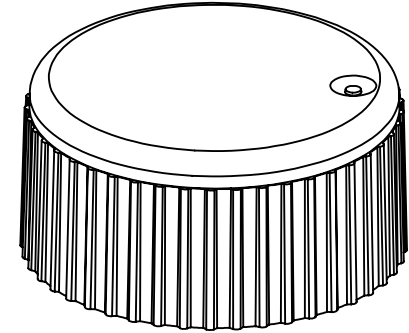

SECTION A-A  
SCALE: 5 : 1

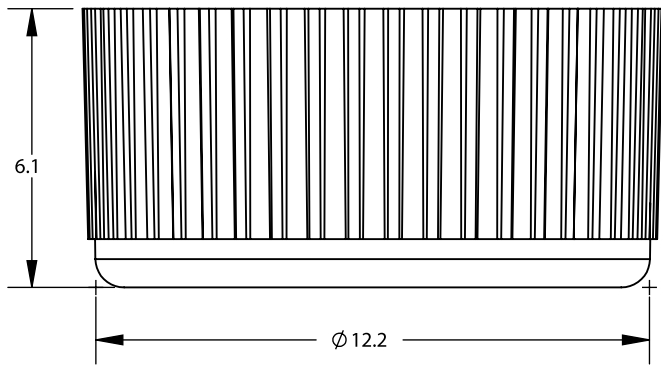

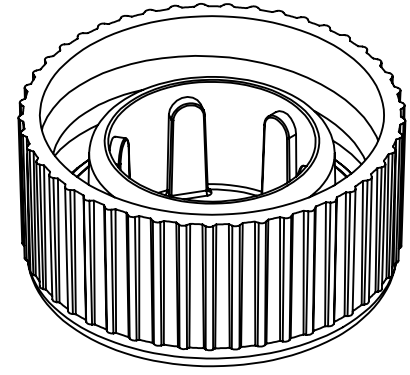

UNLESS OTHERWISE SPECIFIED DIMENSIONS ARE IN MILLIMETERS	CAD GENERATED DRAWING, DO NOT MANUALLY UPDATE		 1310 Thurman Street Lodi CA, 95240 Ph: (209) 333-2120 Fx: (209) 333-8623 info@scientificspecialties.com
	APPROVALS	DATE	
	DRAWN: P. DO	3/21/2018	<b>2001-XX</b> SCREW CAP ASSEMBLY
SSI MATERIAL:	CHECKED:		
MANUFACTURER'S MATERIAL:	RESP ENG:		
FINISH:	MFG ENG:		
DO NOT SCALE DRAWING	QUAL ENG:		SIZE: A SHRINK RATE: SCALE: 1:1 JOB NO.: SHEET: 1 OF 1

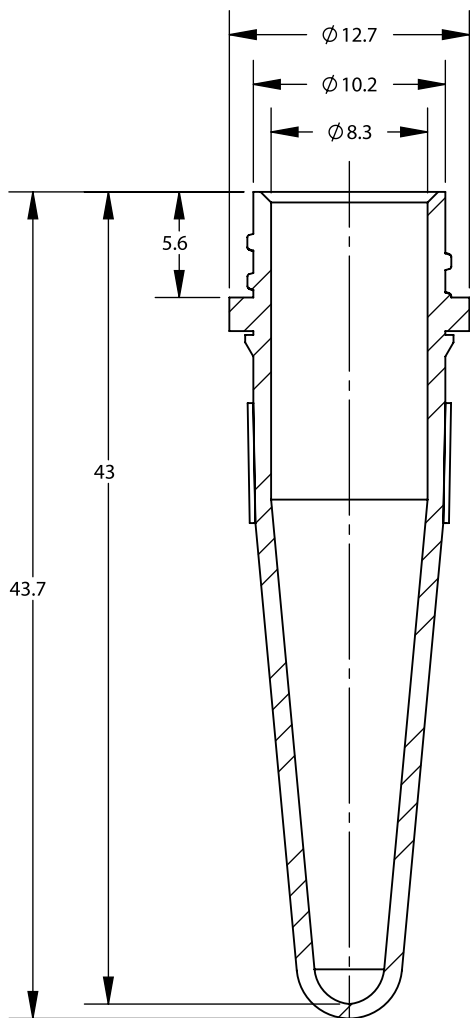
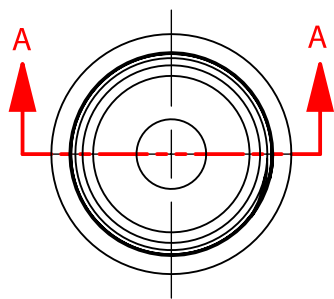
PRINTED 3/21/2018

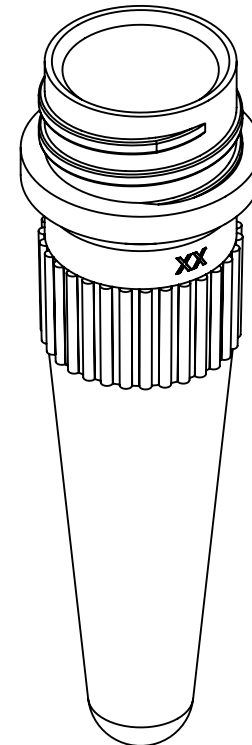

SECTION A-A  
SCALE: 2.5 : 1



UNLESS OTHERWISE SPECIFIED DIMENSIONS ARE IN MILLIMETERS	CAD GENERATED DRAWING, DO NOT MANUALLY UPDATE		 1310 Thurman Street Lodi CA, 95240 Ph: (209) 333-2120 Fx: (209) 333-8623 info@scientificspecialties.com
	APPROVALS	DATE	
	DRAWN: P. DO	7/20/2016	<b>2510-XX</b> 1.5mL SCREW CAP TUBE-CONICAL RIBBED
SSI MATERIAL:	CHECKED:		
MANUFACTURER'S MATERIAL:	DESIGN ENG:		
FINISH:	MFG ENG:		
DO NOT SCALE DRAWING	QUAL ENG:		SIZE: A SHRINK RATE: SCALE: 1:1 JOB NO.: SHEET: 1 OF 1

PRINTED 7/20/2016